



ENAPART



93 S Railroad Avenue Unit C
Bergenfield NJ 07621 USA
www.enapart.com
sales@enapart.com



Via del Canneto 35,
Borgosatollo, Brescia - Italia
www.enapart.it
vendite@enapart.it



Barbaros Mah. Ihlamur Bul. Aĝaoĝlu
My Newwork No:3/15 Ataşehir / İstanbul
www.enapart.net
satis@enapart.net



PRIVADA 10 B SUR #3908 COL.
ANZUREZ, C.P. 72530, PUEBLA, PUE
www.enapart.com.mx
sales@enapart.com.mx



Friedrich-Ebert-Anlage 36, 60325
Frankfurt am Main, Germany
www.enapart.de
anfrage@enapart.de



4 boulevard Carnot, 95400
villiers-le-bel, Paris, France
www.enapart.fr
sales@enapart.fr



65049, ОДЕСА, ВУЛИЦЯ ІВАНА
ФРАНКА, БУДИНОК 55, ПОВЕРХ 3
www.enapart.com.ua
sales@enapart.com.ua



MUNICIPIUL BUCUREȘTI, SECTOR 3,
B-DUL BASARABIA, NR.250, CORP P+5
www.enapart.ro
sales@enapart.ro



〒584-0023 大阪府富田林市若松町
東2丁目2番16号
www.enapart.co.jp
sales@enapart.co.jp



PLAZA NUESTRA SEÑORA DE LAS
NIEVES 12 ,LOCAL ,50012,ZARAGOZA
www.enapart.es
ventas@enapart.es



Складова база „Онгъл“, Склад А2, п.к.
4006, гр. Пловдив, България
www.enapart.bg
sales@enapart.bg



3 Austin Mews, High Street, Hemel
Hempstead, HP1 3AF , United Kingdom
www.enapart.co.uk
sales@enapart.co.uk

Multi Level Switch

UNS-2000 Series

Formerly Series BLS 800

Features

- ▶ Fully customizable
- ▶ Up to 6 independent switch points
- ▶ Reversible switch logic
- ▶ Suitable for high viscosity liquids
- ▶ Optional integral temperature switch
- ▶ Hermetically sealed reed switches

Applications

- ▶ Sump tanks
- ▶ Hydraulic power units
- ▶ Storage tanks
- ▶ Solvent recovery systems
- ▶ Lube oil console systems
- ▶ Marine applications



General Specifications*

Max. Operating Pressure:	580 PSI (40 bar), depends on mounting element and float
Minimum Specific Gravity:	
NBR (BUNA):	0.6 g/cm ³
S.S:	0.78 g/cm ³
Mounting Position:	Vertical, ±30°, through top or bottom
Protection Class:	IP65 for ST-, KL- and PG-design IP67, IP68 on request IP54 for K-design

* See Product Configurator for additional options.

Operating Temperature:	+14 °F to +221 °F (-10 °C to +105 °C), PVC-cable
Special Design Options: (On Request)	DR - Damping Tube HT - High Temperature Application - (-40 °C up to +150 °C) F- Silicone Cable U - Mounting location through bottom PT100 - PT100-Element TP - Temperature switch V V - Vertical Adjustment EXi - ATEX-approval EEx ia
Contact Mode:	NO or NC are defined on the basis of an empty tank and for installation through the top
Weight:	Depends on length and design

Max. Switchpoints

	KL6C AL Terminal Box	KL12C AL Terminal Box	ST1 DIN Connector	ST2 DIN Connector	PG Cable gland
Connect Group 1	5	6	2	5	6
Connect Group 2	2	4	1	2	4
Connect Group 3	3	4	1	3	4
Connect Group 4	2	3	1	2	3

Combinations

Material	Mounting	Electrical Connection	Float
Stainless Steel (VA)	T1-1/4 NPT T2 NPT FLAS	DIN Connector (ST1 & ST2) Terminal box (KL6C or KL12C) Cable gland (PG) PVC Cable (K)	Stainless Steel (VA52)
	1/2 NPT	Cable gland (PG) PVC Cable (K)	
Brass (MS)	T1-1/4 NPT T2 NPT	DIN Connector (ST1 & ST2) Terminal box (KL6C or KL12C) Cable gland (PG) PVC Cable (K)	NBR (Buna-N) (BN30)
	1/2 NPT	Cable gland (PG) PVC Cable (K)	

Wiring Color / Code

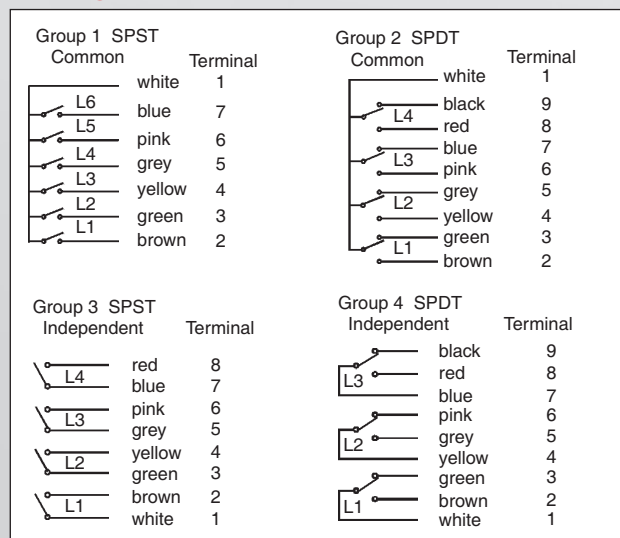

Barksdale®

CONTROL PRODUCTS

Barksdale, Inc./Barksdale GmbH
A Subsidiary of Crane Co.



Multi Level Switch

UNS-2000 Series

Technical Drawing

Formerly Series BLS 800

Dimensions in inch (mm)

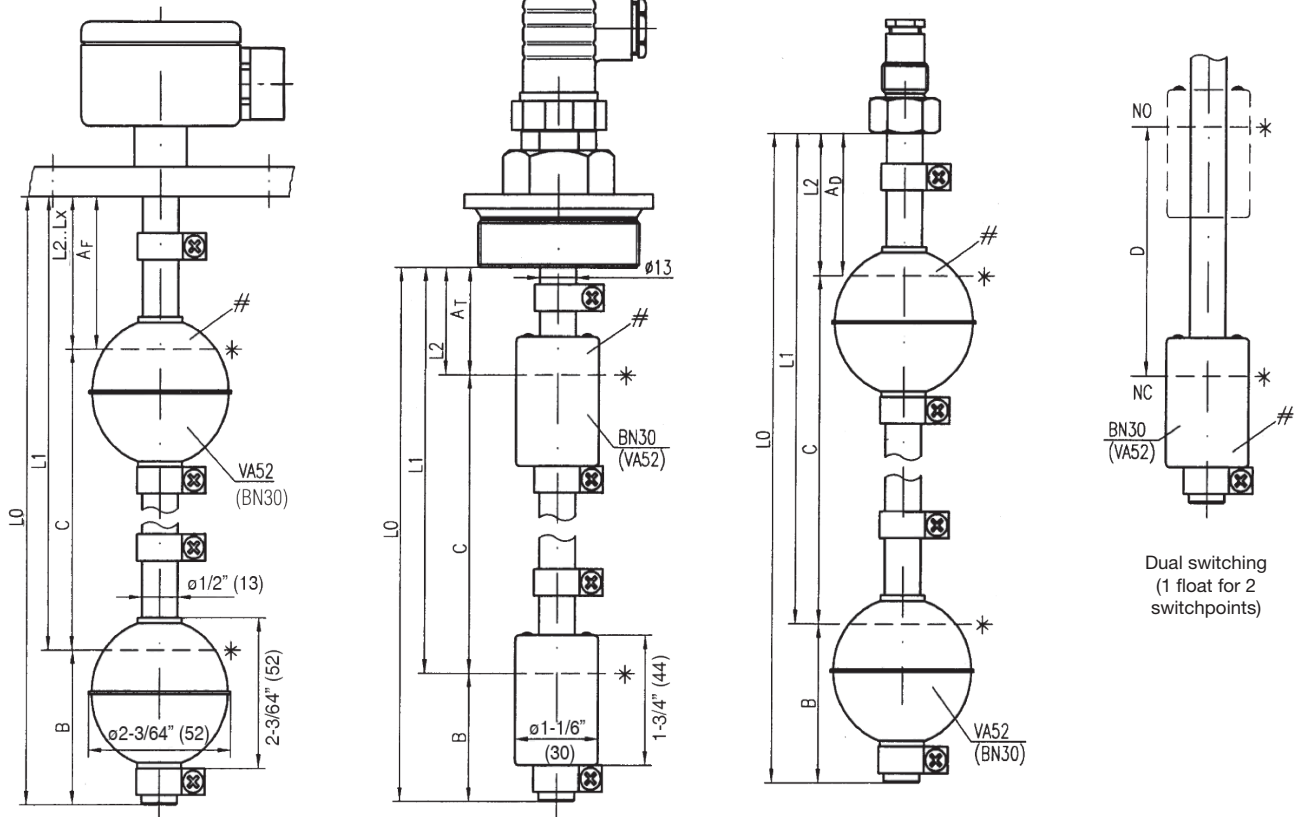

With Aluminum Junction Box and 1/2" NPT female conduit (KL6C or KL12C)

With DIN Connector (ST1)

With Cable gland (PG)

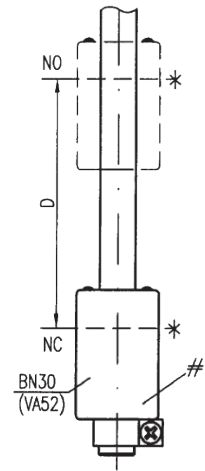

Dual switching (1 float for 2 switchpoints)

Mounting Types:

1. Length tolerance ± 3 mm
2. L0 = max. 3000 mm (118 inches)

- * Immersion depth at density 1:
 VA52 = 36 ± 2 mm
 BN30 = 20 ± 2 mm

- # Float position:
 VA52 = NO/NC \Rightarrow see float marking
 SPDT \Rightarrow NO-function
 BN30 = NO \Rightarrow compound points at bottom
 NC \Rightarrow compound points at top
 SPDT \Rightarrow compound points at bottom

Dimensions	Min. distances in mm					
	A _F	A _T	A _D	B*	C	D
Float type						
VA52	32	32	32	55	85	55
BN30	40	40	40	39	77	55

- *When using -DR: Dimension B + 20 mm!
 *When using -PT100: Dimension is B + 10 mm
 *When using -TPxx/2: Dimension is B + 40 mm

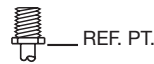

1/2" NPT



T1-1/4" or T2" NPT

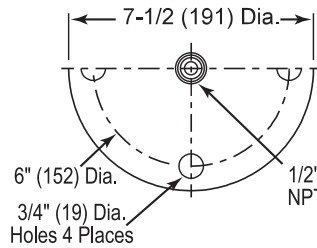

FLA5
 3" 150# Flange
 with 1/2" NPT Male Fitting
 (per applicable ANSI specifications)
 Flange only available in stainless steel.

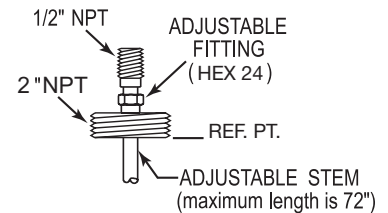

Adjustable Stem
 Only available with flange and 'T' type connections

Multi Level Switch

UNS-2000 Series

Formerly Series BLS-800

UNS-2000 Series Order Form

Check Boxes to Select Specification Requirements

Description:

UNS 2000 - _____ / _____ - _____ - _____ - _____ / _____ - _____

Product Configurator

Example	UNS 2000	-VA	/ T2NPT	-KL6C	-VA52	L2	/ 2.1	-(DR)-(VV)-HT-U-PT100-TP/XX.X-Exi
---------	----------	-----	---------	-------	-------	----	-------	-----------------------------------

Basic Configuration

UNS 2000 Level switches type

Check Required Specs

Material of Stem

- VA SS316
 MS Brass

Mounting Element

- 1/2NPT 1/2" NPT mounting (inside tap)
 T1-1/4NPT 1-1/4" NPT tank screw
 T2NPT 2" NPT tank screw
 FLA5 3" Blind flange (150#)

Electrical Connection¹

- ST1 Cube plug DIN 43650, 3-pin + GND
 ST2 Angle plug DIN 43651, 6-pin + GND
 KL6C Aluminum terminal box, 6 terminals with 1/2" NPT conduit
 KL12C Aluminum terminal box, 9 terminals with 1/2" NPT conduit
 PG PG-cable gland with 1 m PVC-cable
 K PVC-cable sealed, specify length at order
 KXP Explosion proof junction box with 1/2" conduit
 C 1/2" NPT male conduit (VA only)

¹ See "Combinations" section on page 1 for mounting and electrical connection options.

Float Type

	Min. Density	Material	Form	Ø	Max. Temp.	Max. Bar
<input type="checkbox"/> BN30	0.6 g/cm ³	NBR	Cylinder	30 mm 1-3/16	212 °F (100 °C) - Oil 176 °F (80 °C) - Water	15
<input type="checkbox"/> VA52	0.78 g/cm ³	Stainless steel, 316	Ball	52 mm 2-1/16	302 °F (150 °C)	40

No. of Switchpoints²

L=Level, T=Temperature

- L1 1 Switchpoint @ _____ in/mm
 L2 2 Switchpoints @ _____ in/mm
 L3 3 Switchpoints @ _____ in/mm
 L4 4 Switchpoints @ _____ in/mm
 L5 5 Switchpoints @ _____ in/mm
 L6 6 Switchpoints @ _____ in/mm

See also Connection Groups in table "Max. Switchpoints"

Options, please specify when needed

- DR Damping tube
 HT High temperature silicone cable (max 6 wires), (up to +150 °C) 302°F
 U Mounting through bottom
 PT100 PT100-element
 VV Vertical adjustment
 Exi ATEX approval EEx ia
 TP 3A, 12 or 24V DC
 X Contact mode 2 (NC)
 XX Setpoint at rising in °C

Standard +122 °F / +158 °F / +194 °F (+50 °C / +70 °C / +90 °C)
Others on request

Contact Type of Float

	Contact Mode	Contact Rating
<input type="checkbox"/>	1-SPST (NO)	250 V AC / DC, 3 A, 100 VA / W
<input type="checkbox"/>	2-SPST (NC)	250 V AC / DC, 3 A, 100 VA / W
<input type="checkbox"/>	3-SPDT	140 V AC / DC 1 A, 60 VA / W

Must specify with your orders

Check List:

- Overall stem length: L0= _____ (in/mm) (Upto 3000mm std.)
- Add dimensional position of float
- Pick wiring code:

Group 1

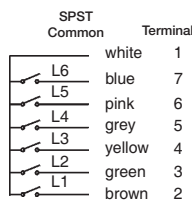

Group 2

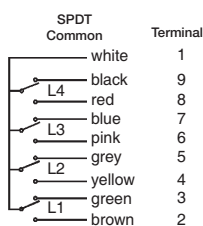

Group 3

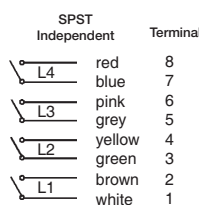

Group 4

