



ENAPART



93 S Railroad Avenue Unit C
Bergenfield NJ 07621 USA
www.enapart.com
sales@enapart.com



Via del Canneto 35,
Borgosatollo, Brescia - Italia
www.enapart.it
vendite@enapart.it



Barbaros Mah. Ihlamur Bul. Aĝaoĝlu
My Newwork No:3/15 Ataşehir / İstanbul
www.enapart.net
satis@enapart.net



PRIVADA 10 B SUR #3908 COL.
ANZUREZ, C.P. 72530, PUEBLA, PUE
www.enapart.com.mx
sales@enapart.com.mx



Friedrich-Ebert-Anlage 36, 60325
Frankfurt am Main, Germany
www.enapart.de
anfrage@enapart.de



4 boulevard Carnot, 95400
villiers-le-bel, Paris, France
www.enapart.fr
sales@enapart.fr



65049, ОДЕСА, ВУЛИЦЯ ІВАНА
ФРАНКА, БУДИНОК 55, ПОВЕРХ 3
www.enapart.com.ua
sales@enapart.com.ua



MUNICIPIUL BUCUREȘTI, SECTOR 3,
B-DUL BASARABIA, NR.250, CORP P+5
www.enapart.ro
sales@enapart.ro



〒584-0023 大阪府富田林市若松町
東2丁目2番16号
www.enapart.co.jp
sales@enapart.co.jp



PLAZA NUESTRA SEÑORA DE LAS
NIEVES 12 ,LOCAL ,50012,ZARAGOZA
www.enapart.es
ventas@enapart.es



Складова база „Онгъл“, Склад А2, п.к.
4006, гр. Пловдив, България
www.enapart.bg
sales@enapart.bg



3 Austin Mews, High Street, Hemel
Hempstead, HP1 3AF , United Kingdom
www.enapart.co.uk
sales@enapart.co.uk

for bolting to the face
with sprag lift-off X



Application as

- ▶ Backstop
- ▶ Overrunning Clutch

For application as backstop in installations with high speeds in freewheeling operation.

For application as overrunning clutch in installations with low speeds in driving operation.

Features

Integrated Freewheels FXM are sprag free-wheels without bearing support and with sprag lift-off X.

The sprag lift-off X ensures a wear-free freewheeling operation when the inner ring rotates at high speed.

Nominal torques up to 1 230 000 Nm.

Bores up to 560 mm. A multitude of standardized bore diameters are available with short delivery times.

Srag lift-off X

Integrated Freewheels FXM are equipped with sprag lift-off X. The sprag lift-off X is used for backstops and overrunning clutches, provided that in freewheeling operation the inner ring is rotating at high speed and providing with overrunning clutches that the driving operation is conducted at low speed. In freewheeling operation, the centrifugal force F_C causes the sprag to lift off from the outer track. In this operating state, the freewheel works wear-free, i.e. with unlimited service life.

Figure 60-2 shows a freewheel with sprag lift-off X in freewheeling operation. The sprags, which are supported in a cage connected with the inner ring, rotate with the inner ring. The centrifugal force F_C that is applied in the center of gravity S of the sprag turns the sprag counterclockwise and rests against the support ring of the cage. This results in the gap a between the sprag and the outer track; the freewheel works without contact. If the inner ring speed decreases to such an extent that the effect of

the centrifugal force on the sprag is less than that of the spring force F_F , the sprag again rests on the outer ring and the freewheel is ready to lock (figure 60-3). If used as an overrunning clutch, the driving speed must not exceed 40% of the lift-off speed.

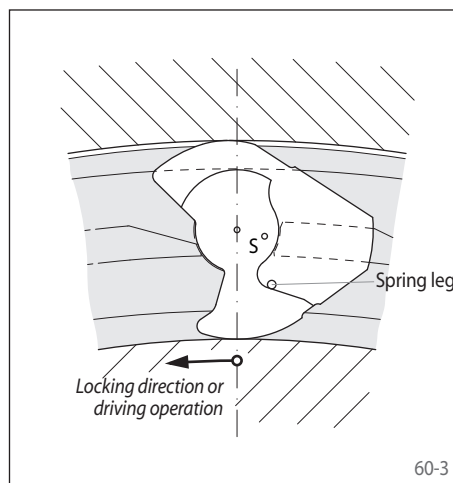
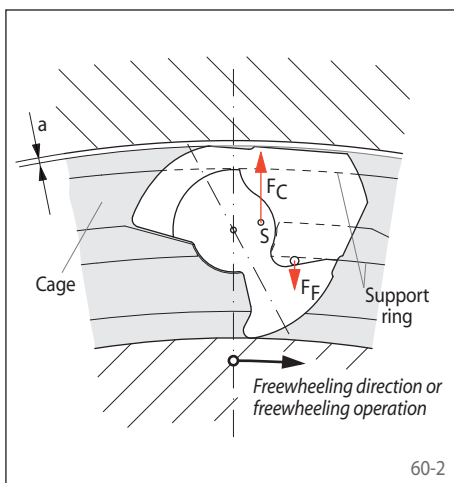

for bolting to the face
with sprag lift-off X

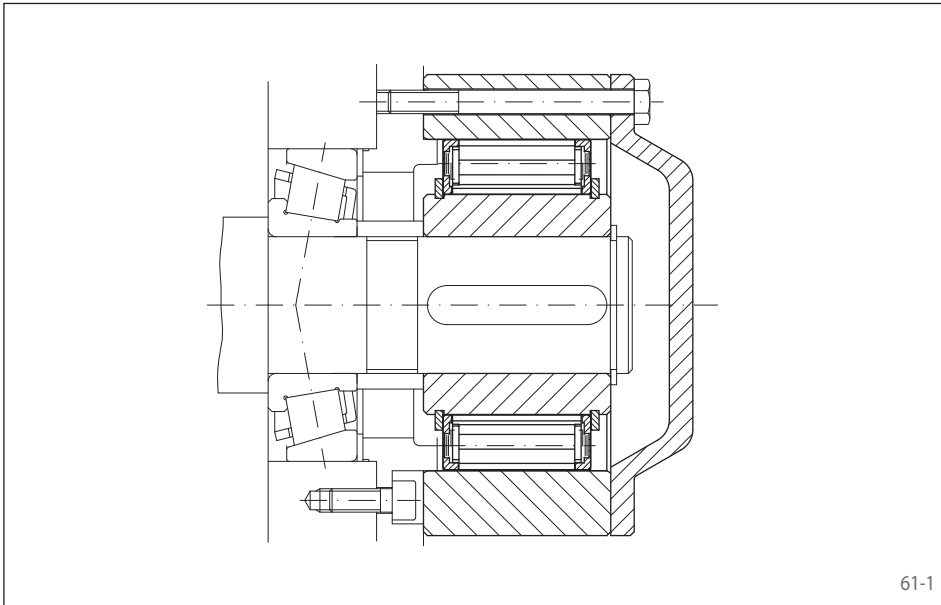

61-1

Application example

Integrated Freewheel FXM 170 - 63 MX with end cover as backstop fitted to the end of the first intermediate shaft of a spur gearbox in the drive of an inclined conveyor belt. In the case of a motor stop, the conveyor belt must be held securely so that the conveyor goods do not pull the belt backwards and possibly cause serious damage. Due to the high shaft speeds in normal operation (freewheeling operation), the sprag lift-off X ensures a contactless and hence wear-free continuous operation.

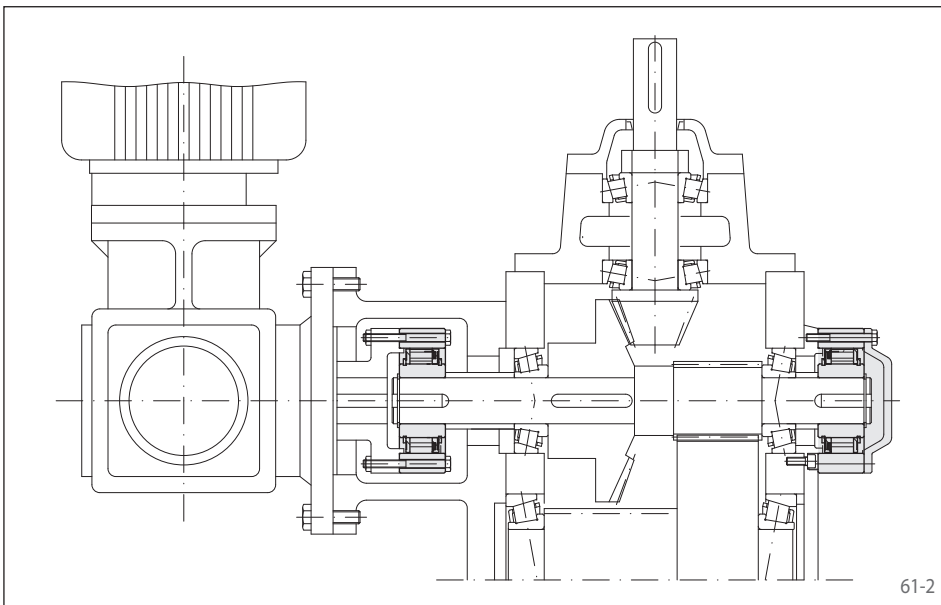

61-2

Application example

Two Integrated Freewheels FXM 120 – 50 MX in the gearbox unit of a vertical bucket conveyor. Alongside the main drive, the bucket conveyor has a creep drive, which can be moved at a low speed if maintenance work needs to be carried out. The freewheel arranged between the creep drive and the main drive works as an overrun clutch. When the creep drive operates, the freewheel is in driving operation. In normal operation, when driving via the main drive, the inner ring of the freewheel overruns at high speed and automatically disengages the creep drive. The second freewheel that is arranged on the end of the first intermediate shaft of the main gearbox, works as a backstop and prevents the bucket conveyor from running back when the unit is at a standstill.

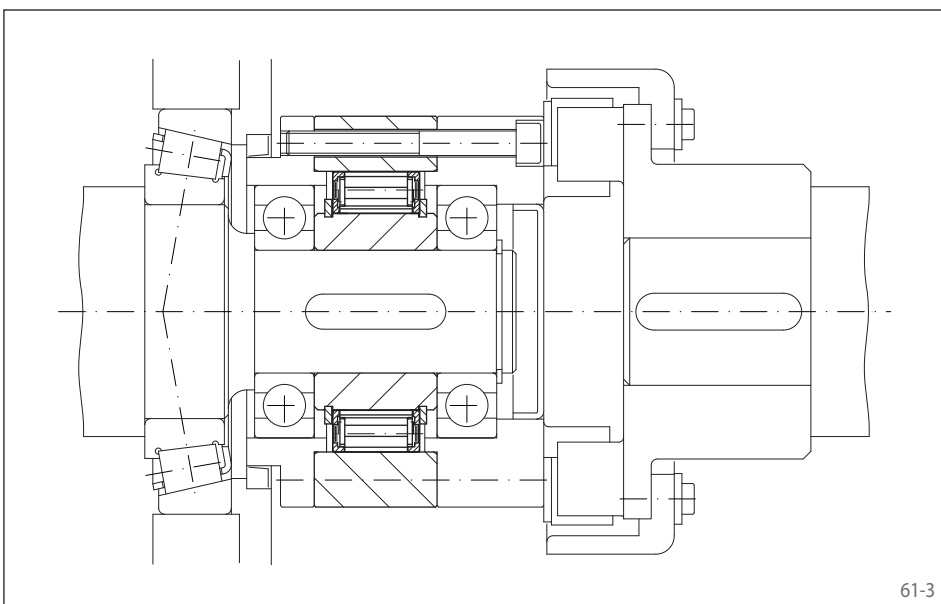

61-3

Application example

Integrated Freewheel FXM 76-25 NX as an overrun clutch between the creep drive and the main drive of a cement mixer. When the creep drive operates, the outer ring is driven by the shaft coupling. The freewheel works in driving operation and drives the unit at a low speed via the main gearbox. In normal operation (freewheeling operation), the inner ring overruns at high speed and the creep drive is automatically disengaged. With the high shaft speed, the type sprag lift-off X is used; the sprags work in freewheeling operation without contact and hence are wear-free. The arrangement of the seals between the freewheel and the main gearbox is advantageous. In freewheeling operation, this is at a standstill and hence generates no additional friction-related temperature rise.

for bolting to the face
with sprag lift-off X

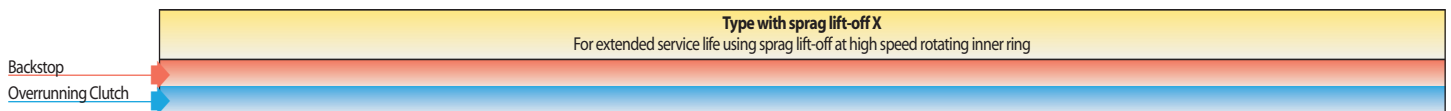
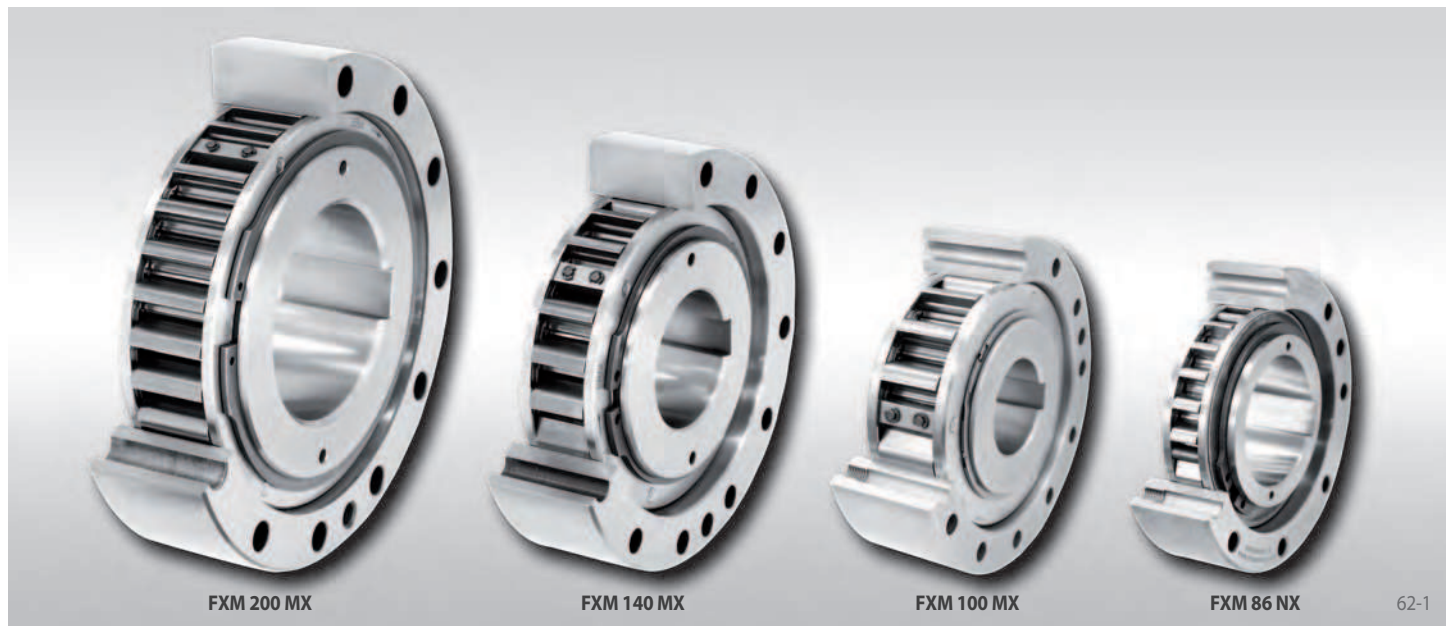

Freewheel Size	Type	Theoretical nominal torque		Nominal torque at existing run out (T.I.R.)						Sprag lift-off at inner ring speed min ⁻¹	Max. speed	
		0 A Nm	0,1 A Nm	0,2 A Nm	0,3 A Nm	0,4 A Nm	0,5 A Nm	Inner ring freewheels/ overruns min ⁻¹	Outer ring drives min ⁻¹			
FXM 31 - 17	NX	110	110	105	100				890	5 000	356	
FXM 38 - 17	NX	180	170	160	150				860	5 000	344	
FXM 46 - 25	NX	460	450	440	430				820	5 000	328	
FXM 51 - 25	NX	560	550	540	530				750	5 000	300	
FXM 56 - 25	NX	660	650	640	630				730	5 000	292	
FXM 61 - 19	NX	520	500	480	460				750	5 000	300	
FXM 66 - 25	NX	950	930	910	890				700	5 000	280	
FXM 76 - 25	NX	1 200	1 170	1 140	1 110				670	5 000	268	
FXM 86 - 25	NX	1 600	1 550	1 500	1 450				630	5 000	252	
FXM 101 - 25	NX	2 100	2 050	2 000	1 950				610	5 000	244	
FXM 85 - 40	MX	2 500	2 500	2 450	2 450	2 450	2 450		430	6 000	172	
FXM 100 - 40	MX	3 700	3 600	3 600	3 500	3 500	3 500		400	4 500	160	
FXM 120 - 50	MX	7 700	7 600	7 500	7 300	7 300	7 300		320	4 000	128	
FXM 140 - 50	MX	10 100	10 000	9 800	9 600	9 500	9 500		320	3 000	128	
FXM 170 - 63	MX	20 500	20 500	20 000	19 500	19 000	19 000		250	2 700	100	
FXM 200 - 63	MX	31 000	30 500	30 000	26 500	23 000	20 500		240	2 100	96	

The maximum transmissible torque is 2 times the specified nominal torque. See page 14 for determination of selection torque.
The theoretical nominal torque applies only for ideal concentricity between the inner and outer ring. In practice, the concentricity is affected by the bearing play and centering errors of the neighbouring parts. Then the nominal torques specified in the table apply, whilst taking into consideration the existing run out (T.I.R.).
Higher speeds upon request.

Mounting

Integrated Freewheels FXM are without bearing support. Concentric alignment of inner and outer ring must be provided by the customer. The permissible run out (T.I.R.) must be observed.

The Integrated Freewheel FXM is centered via the outer track F on the customer attachment part and bolted to this (refer to figure 63-1). The tolerance of the pilot diameter of the attachment part must be ISO h6 or h7.

The tolerance of the shaft must be ISO h6 or j6.

For fitting to shaft ends, end covers can be supplied upon request (refer to figure 63-3).

for bolting to the face
with sprag lift-off X

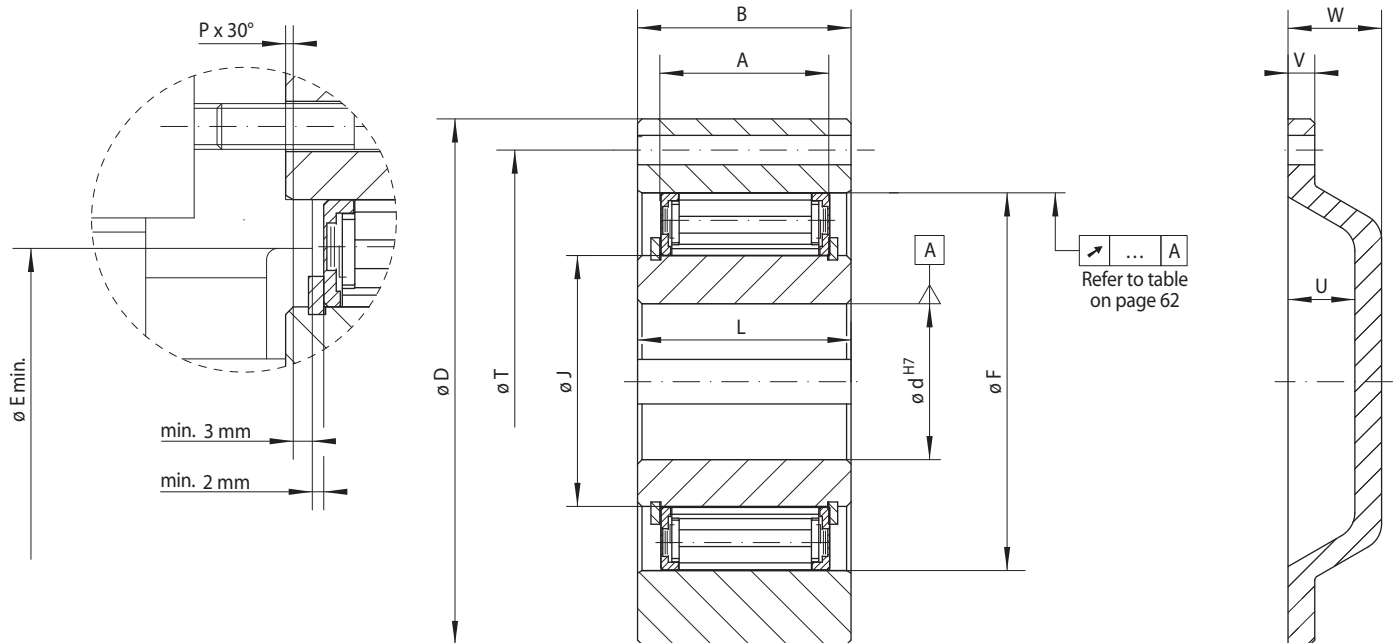

63-1

63-2

63-3

Freewheel Size	Type	Bore d			A	B	D	E min.	F	G**	J	L	P	T	U	V	W	Z**	Weight
		Standard	mm	max. mm															
FXM 31 -17	NX	20*		20*	17	25	85	41	55	M 6	31	24	1,0	70	15	6	21	6	0,8
FXM 38 -17	NX	25*		25*	17	25	90	48	62	M 6	38	24	1,0	75	15	6	21	6	0,9
FXM 46 -25	NX	30		30	25	35	95	56	70	M 6	46	35	1,0	82	15	6	21	6	1,3
FXM 51 -25	NX	35		36	25	35	105	62	75	M 6	51	35	1,0	90	15	6	21	6	1,7
FXM 56 -25	NX	35	40	40	25	35	110	66	80	M 6	56	35	1,0	96	15	6	21	8	1,8
FXM 61 -19	NX	35	40	45*	19	27	120	74	85	M 8	61	25	1,0	105	15	6	21	6	1,8
FXM 66 -25	NX	40	45	48	25	35	132	82	90	M 8	66	35	1,0	115	15	8	23	8	2,8
FXM 76 -25	NX	50	55	60*	25	35	140	92	100	M 8	76	35	1,0	125	15	8	23	8	3,1
FXM 86 -25	NX	50	60	70	25	40	150	102	110	M 8	86	40	1,0	132	15	8	23	8	4,2
FXM 101 -25	NX	75		80*	25	50	175	117	125	M 10	101	50	1,0	155	20	8	28	8	6,9
FXM 85 -40	MX	60		65	40	50	175	102	125	M 10	85	60	1,0	155	20	8	28	8	7,4
FXM 100 -40	MX	70		80*	40	50	190	130	140	M 10	100	60	1,5	165	25	10	35	12	8,8
FXM 120 -50	MX	80		95	50	60	210	150	160	M 10	120	70	1,5	185	25	10	35	12	12,7
FXM 140 -50	MX	90		110	50	70	245	170	180	M 12	140	70	2,0	218	25	12	35	12	19,8
FXM 170 -63	MX	100		130	63	80	290	200	210	M 16	170	80	2,0	258	28	12	38	12	33,0
FXM 200 -63	MX	120		155	63	80	310	230	240	M 16	200	80	2,0	278	32	12	42	12	32,0

Freewheels with bore diameters highlighted blue in the table are available with short delivery times.

Keyway according to DIN 6885, page 1 • Tolerance of keyway width JS10.

* Keyway according to DIN 6885, page 3 • Tolerance of keyway width JS10.

** Z = Number of fastening holes for screws G on pitch circle T.

Lubrication

At speeds in excess of the sprag lift-off speed, no special lubrication is required; the freewheel functions maintenance-free.

When operating below the sprag lift-off speed, an oil lubrication of the specified oil quality must be provided.

Example for ordering

Freewheel size FXM 140 - 50, type with sprag lift-off X and 90 mm bore and end cover:

- FXM 140 - 50 MX, d = 90 mm, with end cover

Integrated Freewheels FXM ... LX

for bolting to the face
with sprag lift-off X

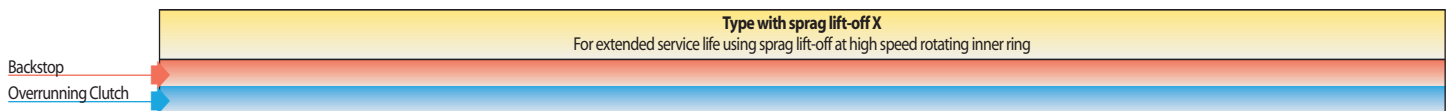

Freewheel Size	Type	Theoretical nominal torque Nm	Nominal torque at existing run out (T.I.R.)						Sprag lift-off at inner ring speed min ⁻¹	Max. speed	
			0,1 A	0,2 A	0,3 A	0,4 A	0,5 A	0,8 A		Inner ring freewheels/overruns min ⁻¹	Outer ring drives min ⁻¹
FXM 240 - 63	LX	36 500	36 000	35 500	35 500	35 000	34 500	34 000	220	3 000	88
FXM 240 - 96	LX	59 000	58 500	58 500	57 500	57 000	56 500	56 000	220	2 500	88
FXM 2.240 - 70	LX	81 000	80 500	80 000	79 500	78 500	77 500	77 000	220	2 500	88
FXM 2.240 - 96	LX	117 500	116 500	116 000	114 500	113 500	112 500	111 500	220	2 500	88
FXM 260 - 63	LX	44 500	44 000	44 000	43 500	43 000	42 500	41 500	210	2 250	84
FXM 290 - 70	LX	65 000	64 500	64 500	63 500	63 500	62 500	60 000	200	2 250	80
FXM 290 - 96	LX	95 500	95 000	94 500	93 500	92 500	91 500	84 500	200	2 250	80
FXM 2.290 - 70	LX	125 500	124 500	123 500	122 500	121 000	119 500	117 000	200	2 250	80
FXM 2.290 - 96	LX	183 000	181 500	180 000	178 500	176 500	174 500	171 000	200	2 250	80
FXM 310 - 70	LX	76 000	75 000	74 500	74 000	73 000	72 500	70 000	195	2 250	78
FXM 310 - 96	LX	112 000	111 000	110 500	109 500	108 000	107 000	99 000	195	2 100	78
FXM 320 - 70	LX	81 000	80 500	80 000	79 500	78 500	78 000	65 500	195	2 000	78
FXM 320 - 96	LX	114 000	113 500	112 500	111 500	110 000	109 000	105 500	195	2 000	78
FXM 2.320 - 70	LX	158 000	156 500	155 500	154 000	152 500	151 000	143 000	195	2 000	78
FXM 2.320 - 96	LX	225 000	223 500	221 500	220 000	217 500	215 000	209 000	195	2 000	78
FXM 360 - 100	LX	156 000	155 000	154 000	152 500	144 000	134 500	108 000	180	1 800	72
FXM 2.360 - 73	LX	208 000	206 500	204 500	203 000	201 000	199 000	163 000	180	1 800	72
FXM 2.360 - 100	LX	294 500	292 500	290 000	287 500	284 500	281 500	258 500	180	1 800	72
FXM 410 - 100	LX	194 500	193 500	192 000	190 000	188 500	179 500	145 000	170	1 500	68
FXM 2.410 - 73	LX	263 000	261 000	259 000	257 000	254 500	252 000	209 500	170	1 500	68
FXM 2.410 - 100	LX	389 500	387 000	384 000	380 500	377 000	359 500	289 500	170	1 500	68
FXM 500 - 100	LX	290 000	287 500	285 500	283 000	272 000	255 000	202 000	150	1 000	60
FXM 2.500 - 100	LX	578 000	574 000	570 000	566 000	547 000	508 000	407 000	150	1 000	60
FXM 620 - 105	LX	444 500	441 500	438 500	427 000	400 000	374 000	300 000	135	1 000	54
FXM 2.620 - 105	LX	888 000	882 000	876 000	860 000	807 000	754 000	603 000	135	1 000	54
FXM 750 - 105	LX	605 000	601 000	596 000	591 000	586 000	579 000	504 000	125	800	50
FXM 2.750 - 105	LX	1 230 000	1 220 000	1 210 000	1 200 000	1 190 000	1 179 000	958 000	125	800	50

The maximum transmissible torque is 2 times the specified nominal torque. See page 14 for determination of selection torque.
The theoretical nominal torque applies only for ideal concentricity between the inner and outer ring. In practice, the concentricity is affected by the bearing play and centering errors of the neighbouring parts. Then the nominal torques specified in the table apply, whilst taking into consideration the existing run out (T.I.R.).
Higher speeds upon request.

Mounting

Integrated Freewheels FXM are without bearing support. Concentric alignment of inner and outer ring must be provided by the customer. The permissible run out (T.I.R.) must be observed.

The Integrated Freewheel FXM is centered via the outer track F on the customer attachment part and bolted to this (refer to figure 65-1). The tolerance of the pilot diameter of the attachment part must be ISO h6 or h7.

The tolerance of the shaft must be ISO h6 or j6.

for bolting to the face
with sprag lift-off X

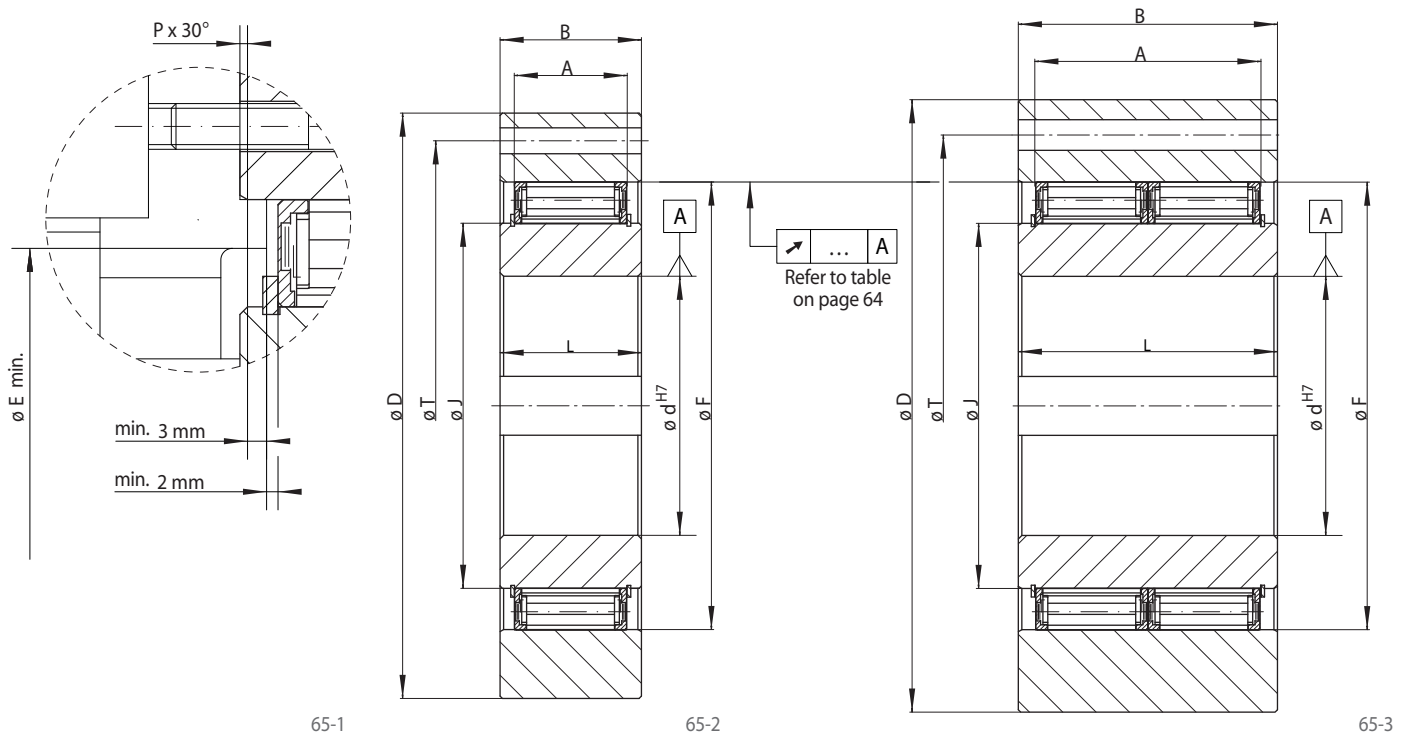

Freewheel Size	Type	Bore d max. mm	A mm	B mm	D mm	E min. mm	F mm	G*	J mm	L mm	P mm	T mm	Z*	Weight kg
FXM 240 - 63	LX	185	63	80	400	280	310	M 20	240	90	2,0	360	12	60
FXM 240 - 96	LX	185	96	125	420	280	310	M 24	240	120	2,0	370	16	95
FXM 2.240 - 70	LX	185	140	160	412	280	310	M 20	240	160	2,0	360	24	120
FXM 2.240 - 96	LX	185	192	240	425	280	310	M 24	240	240	2,0	370	24	200
FXM 260 - 63	LX	205	63	80	430	300	330	M 20	260	105	2,0	380	16	75
FXM 290 - 70	LX	230	70	80	460	330	360	M 20	290	105	2,0	410	16	90
FXM 290 - 96	LX	230	96	110	460	330	360	M 20	290	120	2,0	410	16	91
FXM 2.290 - 70	LX	230	140	160	480	330	360	M 24	290	160	2,0	410	18	170
FXM 2.290 - 96	LX	230	192	240	490	330	360	M 30	290	240	2,0	425	20	260
FXM 310 - 70	LX	240	70	125	497	360	380	M 20	310	110	3,0	450	24	135
FXM 310 - 96	LX	240	96	125	497	360	380	M 20	310	120	3,0	450	24	145
FXM 320 - 70	LX	250	70	80	490	360	390	M 24	320	105	3,0	440	16	105
FXM 320 - 96	LX	250	96	120	520	360	390	M 24	320	120	3,0	440	16	150
FXM 2.320 - 70	LX	250	140	180	505	360	390	M 24	320	180	3,0	440	24	200
FXM 2.320 - 96	LX	250	192	240	530	360	390	M 30	320	240	3,0	460	24	310
FXM 360 - 100	LX	280	100	120	540	400	430	M 24	360	125	3,0	500	24	170
FXM 2.360 - 73	LX	280	146	210	550	400	430	M 24	360	210	3,0	500	24	270
FXM 2.360 - 100	LX	280	200	250	580	400	430	M 30	360	250	3,0	500	24	380
FXM 410 - 100	LX	300	100	120	630	460	480	M 24	410	125	3,0	560	24	245
FXM 2.410 - 73	LX	300	146	210	630	460	480	M 24	410	210	3,0	560	24	400
FXM 2.410 - 100	LX	300	200	220	630	460	480	M 30	410	220	3,0	560	24	440
FXM 500 - 100	LX	360	100	130	780	550	570	M 30	500	130	3,0	680	24	310
FXM 2.500 - 100	LX	360	200	230	780	550	570	M 30	500	230	3,0	680	24	560
FXM 620 - 105	LX	460	105	140	980	670	690	M 30	620	140	3,0	840	24	570
FXM 2.620 - 105	LX	460	210	240	980	670	690	M 36	620	240	3,0	840	24	990
FXM 750 - 105	LX	560	105	150	1 350	800	820	M 42	750	150	3,0	1 000	24	1 330
FXM 2.750 - 105	LX	560	210	250	1 350	800	820	M 42	750	250	3,0	1 000	24	2 620

Keyway according to DIN 6885, page 1 • Tolerance of keyway width JS10.

* Z = Number of fastening holes for screws G on pitch circle T.

Lubrication

At speeds in excess of the sprag lift-off speed, no special lubrication is required; the freewheel functions maintenance-free.

When operating below the sprag lift-off speed, an oil lubrication of the specified oil quality must be provided.

Example for ordering

Freewheel size FXM 240 - 63, type with sprag lift-off X and 185 mm bore:

- FXM 240 - 63 LX, d = 185 mm