

Digital temperature controller

AX series**INSTRUCTION MANUAL**

Thank you for purchasing HANYOUNG product.
Please check whether the product is the exactly same as you ordered.
Before using the product, please read this instruction manual carefully.
Please keep this manual where you can view at any time

**HANYOUNG NUX****HANYOUNGNUX CO.,LTD**

HEAD OFFICE 1381-3, Juan-Dong, Nam-Gu Incheon, Korea, TEL:(82-32)876-4697 FAX:(82-32)876-4696 http://www.hynux.net

Safety information

Alerts declared in the manual are classified to Danger, Warning and Caution by their criticality

	DANGER	DANGER indicates an imminently hazardous situation which, if not avoided, will result in death or serious injury
	WARNING	WARNING indicates a potentially hazardous situation which, if not avoided, could result in death or serious injury
	CAUTION	CAUTION indicates a potentially hazardous situation which, if not avoided, may result in minor or moderate injury

Danger

The electric shock may occur in the input/output terminal so please never let your body and/or conductive substance to be contacted by the input/output terminal.

Warning

- Since this product is not designed as a safely used device the user must install double safety equipment when this product is used for equipment with possible fatal accident or large property damage.
- The power switch and fuse are not installed on this product so users need to install them separately on the outside. (Fuse rating: 250V 0.5A)
- Please supply in the rated power supply voltage in order to prevent this product from breaking down or damaged.
- This is not designed as explosion-protective structure so avoid using this product at places where gas inflammability and explosive gases exist.
- Do not supply in the power until all wiring is fully completed in order to prevent the product from breaking down and prevent users from getting electric shock.
- Do not disassemble, manufacture, upgrade and repair the product by yourself. Doing so will break down the product, generate the electric shock and cause malfunction to occur.
- Please turn OFF the product and disassemble the product. Not doing so will break down the product, generate the electric shock and cause malfunction to occur.
- Electric shock may occur when operating this product so please install this product to the panel and use it

Caution

- The contents of this manual may be changed without prior notification
- Please check for correct model type and specification
- Please check for any damage or abnormality may caused during shipment.
- Please use this product at following range.
Ambient temperature: -5 ~ 50 °C (when installing them close to each other, max. 40 °C) / humidity : 35 ~ 85 % R.H (but without dew condensation)
- Please avoid the places where corrosive gas(especially noxious gas, ammonia and etc) and inflammable gas exist
- Please do not use this product at places where the vibration or impact is applied directly.
- Please avoid the places where liquid, oil, medical substances, dust, salt or iron contents exist(avoid place of pollution level 1 or 2)
- Do not clean the product with the organic solvent such as alcohols, benzene and etc. (Use neutral detergents)
- Please avoid the places where huge inductive interference exists and places where static electricity/self noise are generated.
- Please avoid the places where heat accumulates due to the direct sunlight, radiation and etc
- We recommend using it at altitude below the 2000 m.
- If the device is touched or contacted by water then short-circuit and fire may occur so please inspect the device carefully.
- With the thermocouple input, please use the stated compensation cable. (Using regular compensation cable will generate the temperature error)
- With the RTD input, please use the cable with less lead-wire resistance and no difference in the resistance among 3-wires. (Using regular cable will generate the temperature error)
- For the input signal wire, please avoid from the power line and load line in order to avoid from the induction noise.
- Separate the input signal wire and output signal wire and if separating them from each other is impossible, then please use the shield wire for the input signal wire.
- For the thermocouple, please use it as the un-grounding type. (When using the grounding type, malfunction may occur due to the electric leakage)
- When there are too much noises generating from the power, we recommend using the insulation Trans and noise filter. Noise filter must be mounted to the panel or etc that is grounded and please try to make the wiring of output and power terminal meter as short as possible.
- Tightly twisting the power line meter will reduce the noise generation
- If alarm function is not set properly, alarm will not be generated when it should so please check for the operation before running the product.
- When replacing the sensor, please turn OFF the power
- If operation frequency is too high (such as proportional operation and etc) and connecting the maximum rated load to output relay will shorten the life expectancy therefore, please use the auxiliary relay. We recommend using the SSR output type in such cases.
- When using the electrical switch: Set proportional cycle min 20 sec
- When using the SSR: Set proportional cycle min 1 sec
- Do not wire anything to the un-using terminal
- Please check the polarity of terminal before wiring.
- When installing this product to the panel, please use the authorized switch or circuit breaker (authorized by IEC60947-1 or IEC60947-3)
- Please install the switch or circuit breaker close to the operator for users' convenience
- Because switch or circuit breaker is being installed, please make a note on the panel that operating the switch or circuit breaker will block the power.
- We recommend the continuous inspection and repair in order to use it safely for a long period of time.
- Some parts in this product have life expectancy and gets old as time elapses.
- The warranty period is one year including the parts only under the condition where the product is used properly

- It needs the preparation time for contact output when supplying in the power. When applied as signal to the external interlock circuit and etc, please jointly use the delay relay.
- When changing the instrument or if the product broke down, users can replace with the prepared product but even suffix code stays same, operation may differ due to the parameter difference so please check for the compatibility and perform such action.
- Before using a temperature controller, there could be a temperature difference between PV of the temperature controller and the actual temperature so please operate the temperature controller after compensating the temperature difference appropriately.

Suffix code

Model	Code	Information
AX	<input type="checkbox"/> - <input type="checkbox"/> <input type="checkbox"/>	Digital temperature controller
Dimension	2	AX2 : 48 X 96 mm
	3	AX3 : 96 X 48 mm
	4	AX4 : 48 X 48 mm
	7	AX7 : 72 X 72 mm
	9	AX9 : 96 X 96 mm
Output selection	1	SSR + Relay1 + Relay2
	2	SSR + Relay1 + Relay2 + Relay3
	3	4 - 20 mA + Relay2
	4	4 - 20 mA + Relay2 + Relay3
Power supply voltage	A	100 - 240 V a.c 50/60 Hz

* Relay output operates as control output, alarm output and LBA output depending on the internal parameter setting.

Input

Input selection	Multi input • Thermocouple : K, J, R, T (IEC) • RTD : Pt100 Ω (IEC)
Input sampling time	0.1 s
Input impedance	1 MΩ max
Allowable wiring resistance	10 Ω / 1wire max(RTD). but resistances among 3 wires should be same
Allowable input voltage	10 V d.c max

Performance

Display accuracy	±0.3 % of F.S ±1 digit (In case of R type, ±1.0 % of ±1 digit in the 0 ~ 600 °C range)
Insulation resistance	More than 20 MΩ, 500V d.c for 1min (Primary terminal-Secondary terminal)
Dielectric strength	2300V a.c 50/60Hz, for 1 min (Primary terminal-Secondary terminal)

Range and input code

Classification	Code	Input type	Range	
			Celsius(°C)	Fahrenheit(°F)
Thermocouple	\mathcal{K} 1	K	-100 ~ 1200 °C	-148 ~ 2192 °F
	\mathcal{K} 2		-100.0 ~ 500.0 °C	-148 ~ 932 °F
	\mathcal{J}	J	-100.0 ~ 500.0 °C	-148 ~ 932 °F
	\mathcal{R}	R	0 ~ 1700 °C	32 ~ 3092 °F
	\mathcal{T}	T	-100.0 ~ 400.0 °C	-148 ~ 752 °F
RTD	$\mathcal{P}\mathcal{L}$	Pt100 Ω	-100.0 ~ 400.0 °C	-148.0 ~ 752.0 °F

Control function and output

- Control type : PID control, P control, ON/OFF control
- Auto-tuning : PID operation by the auto-tuning
- ON/OFF control : When PV > SV, it generates 0 % output. When PV < SV, it generates 100 % output. (Only when control hysteresis is 0)
- Manual reset : Users set within the range from 0 % to 100 %.
- Control output operation : Direct action/Reverse action (selected by the parameter setting)
- Control output : Relay output/voltage pulse output (SSR output) * Selected by the parameter setting

Relay	1a contact (Resistive load)	
	<ul style="list-style-type: none"> Relay output can be selected maximum 3 and relay control output is displayed as RLY1. Alarm output 2 contacts (AL1, AL2) and LBA output are assigned by the users among RLY1, RLY2 and RLY3 	
S.S.R	CYC PHA	12 – 15 V d.c pulse voltage (resistive load min 600 Ω)
4 – 20 mA	Accuracy : 0.5 % of F.S, Ripple Vp-p : 0.3 % of F.S, Resistive load : Max 600 Ω	

Specification

Model	AX2	AX3	AX4	AX7	AX9
Power supply voltage	100 – 240 V a.c 50/60 Hz				
Voltage fluctuation	±10 % of power supply voltage				
Power consumption	5.5 VA max				
Ambient temperature	-5 ~ 50 °C				
Ambient humidity	35 ~ 85 % R.H(But without dew condensation)				
Vibration (resistance)	10 – 55 Hz, 0.75 mm, X Y Z each in X, Y and Z directions for 2 hour				
Shock (resistance)	300 m/s ² to 6 directions each 3 times				
Weight	320 g	320 g	180 g	300 g	400 g

※ Weight included the weight of box

Function and name of each part



No	Model	Information
①	Process value (PV)	Display the current temperature in the operation screen
②	Set value (SV)	Display the set temperature in the operation screen
③	▲ Up Key	• Change the operation screen, increase the set value, move to the parameter setting mode
④	▼ Down Key	• Decrease the set value, move to the parameter setting mode
⑤	◀ Shift Key	• Shift to the set value digits • Move from operation screen – users • Move from operator – setting mode
⑥	MODE Mode Key	• Move from operation screen – users • Move from operator – setting mode
⑦	AT	Light ON with the PID auto tuning
	OUT	Light ON with the control output operation
	AL1	Light ON with the Alarm1 operation
	AL2	Light ON with the Alarm2 operation
	LBA	Light ON with the Loop break alarm operation

Main function explanation

Input type selection (Sensor type selection)

AX series is designed as multi input type so it allows users to select the desired sensor among thermocouple K, thermocouple J, thermocouple R, thermocouple T and RTD (Pt100 Ω) depending on the input selecting parameter of operator setting mode disregarding the suffix code.

Control output selection

AX series is divided into the "SSR output and relay output" or "current output" depending on the suffix code. In case of when suffix code is AX□-1 or AX□-2, please select the SSR or relay output in the "control output type (**Ctrl**)" of the operation setting mode and use it. However, when SSR control output is selected, users can able to assign the relay 1 (RLY1) output as the alarm output (alarm1 output, alarm2 output, LBA output). In case of when suffix code is AX□-3 or AX□-4, control output is fixed as the current output (4 – 20 mA d.c).

Model	Control output	Reference
AX□-1 or AX□-2	SSR or Relay(RLY 1)	Selected depending on the internal parameter(But, Able to assign the relay1 as alarm output ,when SSR output is selected)
AX□-3 or AX□-4	Current output(4 – 20 mA d.c)	fixed

Heating/Cooling output action selection

Able to select the reverse action (heating control) or direct action (cooling control) output by the **Ctrl** parameter

PID auto tuning (A.T) function

Auto tuning function measures, computes and sets the optimum PID or ARW constant automatically. After supplying power in and while temperature is increasing, press the set key **MODE** and **▲** key synchronously for 2 sec. to begin the auto tuning. When auto tuning is finished, tuning operation will be ended automatically.

ON/OFF control setting method

Usually temperature controller performs the temperature control by "PID control method" which is done by the PI auto tuning. However, ON/OFF control method is used when controlling the refrigerator, fan, solenoid valve and etc. When users want to set the temperature controller as ON/OFF control mode, set the setting value of proportional band as **Ctrl** within the "general setting parameter." Here, **HYS** (hysteresis) parameter will be displayed. Prevent such action to occur by setting the desired ON/OFF action range.

bold display

When input break (sensor break) occurs or exceeds the maximum temperature range, **bold** will be displayed in the measured value displaying unit.

Alarm

Using the alarm

AX series supports 2 independent alarms (AL1 and AL2). These alarms can allocate AL1 or AL2 signal in the RLY1, RLY2 and RLY3 and be used. If alarm signal is not allocated in the RLY1 to RLY3 then the menu related to the alarm will not be displayed.

Alarm hold action

If there is no standby action function, supply the power in then the LOW alarm will become ON while temperature is increasing.

In order to prevent the low alarm to become ON during temperature is increasing, add the standby action function so from the point when supplying in the power to until the value goes beyond the set value, it can prevent the low alarm to be operated.

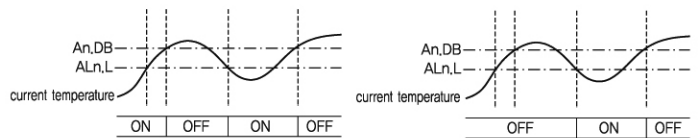

Not using the alarm standby mode (An,HD=OFF)

Using the alarm standby mode (An,HD=ON)

Alarm output LOCK

If the **AlnH** value is ON, Alarm is not cancelled even if it becomes the alarm cancel condition. If users want to stop the alarm forcedly, please press the **▲** key for approx 2 sec.

LBA (Loop Break Alarm)

LBA function starts to measure time from the moment when the PID computed value becomes 0 % or 100 %. Also, from this point, this function detects heater break, sensor break manipulator malfunction and etc by comparing the changed amount of measured value in each set time. Also, it can set the LBA dead band in order to prevent any malfunction to happen in the normal control loop.

① When control output value which obtained by PID operation is 100 %,

If the temperature does increase more than **LbRu** value within the LBA set time, LBA output will become ON

② When control output value which obtained by PID operation is 0 %,

If the temperature does decrease more than **LbRl** value within the LBA set time, LBA output will become ON

Timeshare cycle control and phase control of Voltage pulse output

When selecting the control output type as SSR, users will be able to select the types for voltage pulse output. The timeshare cycle control turns ON/OFF the output by proportioning the certain time to an output amount in cycle. Set the cycle of control output in the **Ctrl** parameter.

Within the half cycle of power wave shape, the phase control (depending on an output amount) controls an output amount by computing the output ON phase. However, when using the phase control, users must use the RANDOM ON/OFF type SSR.

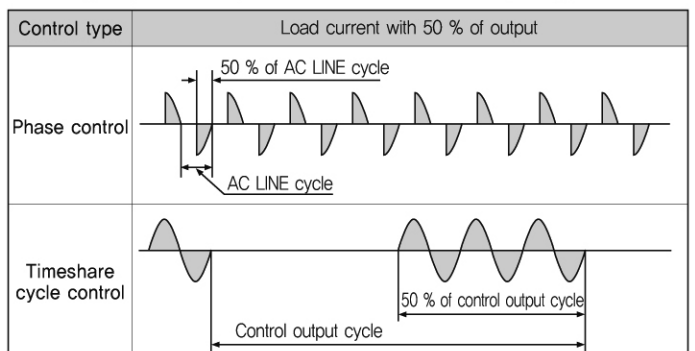

Parameter composition

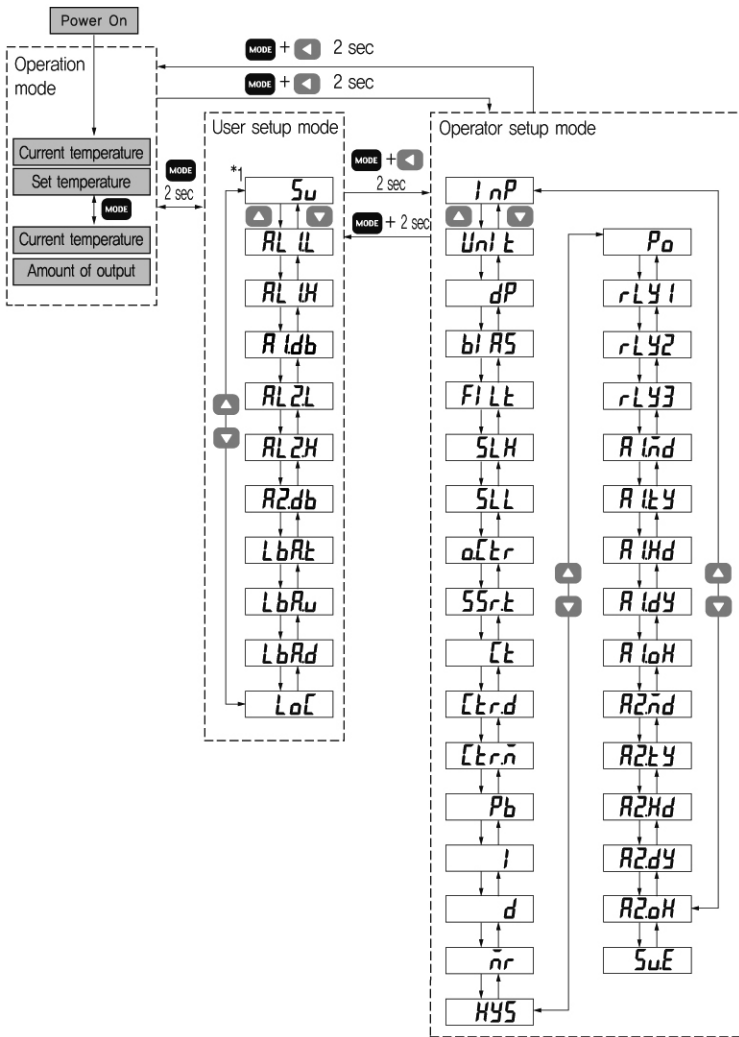

■ Operation mode

Supplying in the power after finish wiring will display the current temperature. Pressing the **MODE** key will display the set temperature and output amount alternatively on the set value (SV) displaying unit.

■ User setup mode

User setup mode is the setting mode that sets the set value that is changed by users frequently such as alarm set value and loop break alarm (LBA). It made the parameter of user setup mode to be displayed on the operator setup mode that allows users to set easily (divided the setting level).

Set Value(SV) can be set up in the User setup mode (When **Su** is displayed, push shift key (**◀**) to change set value) Change set value by **◀**, **▶**, **▲** key and push **MODE** key.

Symbol (PV)	Lists	Information	Display condition	Default value (SV)
Su	set temperature	EU 0 ~ 100 %	at all times	EU 0 %
AL lL	Alarm 1 low value	EU 0 ~ 100 % or EUS 0 ~ 100 % (temperature unit)	When RLYn ALn is set	EU 0 %
AL lH	Alarm 1 high value			EU 100 %
AL db	Alarm 1 dead zone			EUS 0 %
AL 2L	Alarm 2 low value			EU 0 %
AL 2H	Alarm 2 high value			EU 100 %
AL 2db	Alarm 2 dead zone			EUS 0 %
LbRt	Loop break alarm time	0 ~ 7200 second	When LBA is set in the RLYn	480
LbRu	Loop break alarm temperature	0 ~ 100 °C (°F)		2
LbRd	Loop break alarm dead zone	0 ~ 100 °C (°F)		2
LoL	KEY lock	0 : NO LOCK function	at all times	0
		1 : Operator setup mode LOCK, Auto-tuning prohibited		
		2 : Operator and user setup mode LOCK		

■ Operator setup mode

Operator setup mode is the setting mode that sets the specification of temperature controller when engineer installs it for the first time. Pressing the **MODE** key and **◀** key synchronously in the operation screen or user setup mode will enter into the operator setup mode. Pressing **MODE** and **◀** keys one more time for 2 sec will return to the operation screen.

Symbol (PV)	Lists	Information	display condition	Default value
InP	Input condition	Y1 : K thermocouple (Not display the decimal points) Y2 : K thermocouple (Displays the decimal points) J : J thermocouple R : R thermocouple T : T thermocouple Pt : RTD Pt 100 Ω	At all times	Y1
Unit	Temperature unit	°C / °F option	At all times	°C
dP	Decimal point	ON(YES) OFF(NO)	Select decimal point	on
biRS	Input compensation	-100 ~ 100(sensor input value + BIAS)	At all times	0
FilT	Input filter time	0 ~ 120 sec	At all times	0
SLH	High setting limitation	EU 0 ~ 100 %	At all times	1200
SLL	Low setting limitation	EU 0 ~ 100 %	At all times	-100
aCtr	Control output type	SSr : SSR operating voltage pulse output rLY : Relay output	When output selection 1 or 2	SSr
SSrT	Voltage pulse output type	CYC : Timeshare proportional control PHR : SSR phase control (continuously proportioning)	When selected SSR control output	CYC
Ct	Control output cycle	0 ~ 1000 sec	When SSrT is CYC or aCtr is RLY	2
Ctrd	Control output action	rEu : Reverse action (heating control) dir : Direct action (cooling control)	At all times	rEu
Ctrn	Control type	PI d : PID control P : P control (proportional control) onof : ON/OFF control	At all times	PI d
Pb	Proportional band	1 (0.1) ~ EUS 100 %	When it is not ON/OFF control	30
I	Integral time	0 ~ 3600 sec	With PID control	240
d	Derivative time	0 ~ 3600 sec	With PID control	60
nr	Manual reset	0.0 ~ 100.0 %	With P control	500
HYS	Control hysteresis	EUS 0 ~ 100 % (Temperature unit)	With ON/OFF control	2
Po	Output amount with input break	0 ~ 100 %	At all times	00
rLY1	Relay 1 property	non : Not using RL1 : Alarm 1 output RL2 : Alarm 2 output LbR : LBA output	When output selection is 1 or 2 and aCtr is not RLY	non
rLY2	Relay 2 property	non : Not using RL1 : Alarm 1 output RL2 : Alarm 2 output LbR : LBA output	At all times	RL1
rLY3	Relay 3 property	non : Not using RL1 : Alarm 1 output RL2 : Alarm 2 output LbR : LBA output	At all times (Option)	RL2
R lnd	Alarm 1 mode (Alarm 1 or 2)	non : Not using ---[: High alarm]----: Low alarm	When AL1 or AL2 is set in RLY 1, 2, 3	---[
R 2nd	Alarm 2 mode (Alarm 1 or 2)	-[]- : Alarm within range]--[: Alarm not within range]----
R lty	Alarm 1 type	Rb5 : ABS(Absolute alarm)		Rb5
R 2ty	Alarm 2 type	dEu : DEV(Deviation alarm)		Rb5
R lHd	Alarm 1 standby mode	oFF : OFF(not using the standby mode)		oFF
R 2Hd	Alarm 2 standby mode	on : ON(using the standby mode)		oFF
R ldy	Alarm 1 delay time	0 ~ 9999 sec	0	
R 2dy	Alarm 2 delay time	0 ~ 9999 sec	0	
R loH	Alarm 1 output LOCK	oFF : Alarm output return action	oFF	
R 2oH	Alarm 2 output LOCK	on : Alarm output maintain action	oFF	
SuE	Change SV on the operation	oFF : No change SV on : Change SV	At all times	oFF

AX2

● Dimension

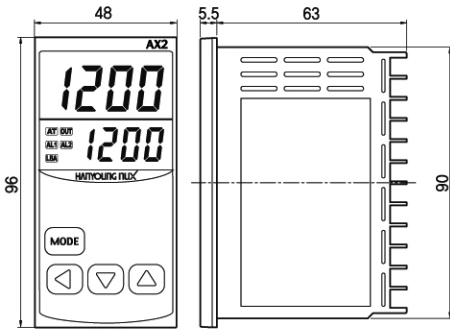

● Panel cutout

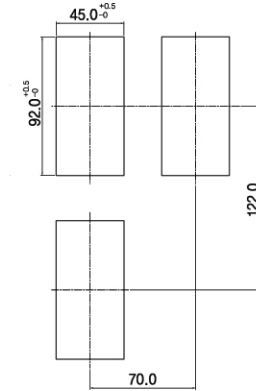

● Connection diagram

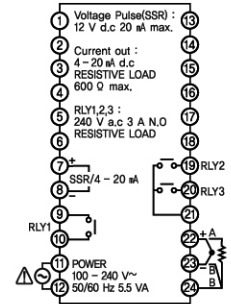

AX3

● Dimension

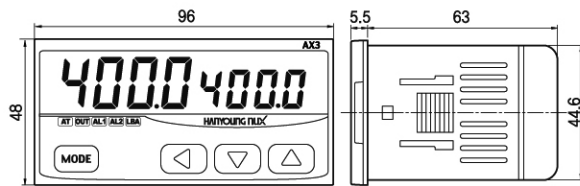

● Panel cutout

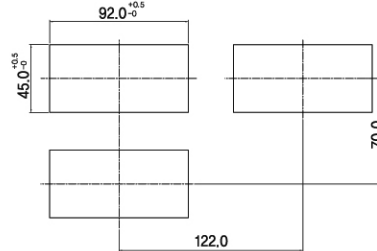

● Connection diagram

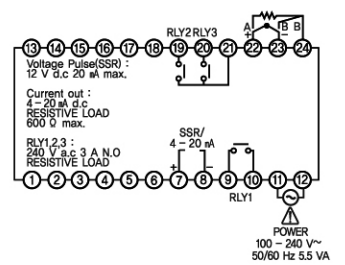

AX4

● Dimension

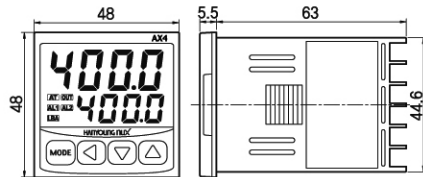

● Panel cutout

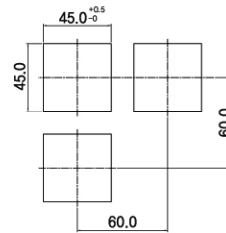

● Connection diagram

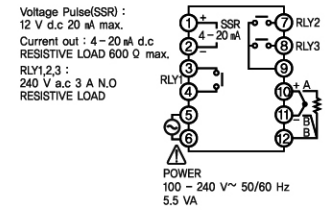

AX7

● Dimension

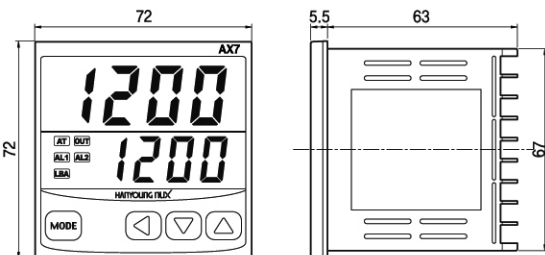

● Panel cutout

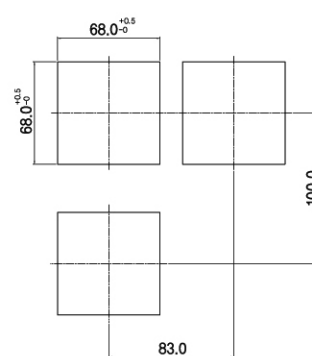

● Connection diagram

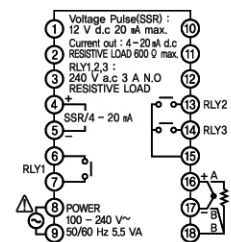

AX9

● Dimension

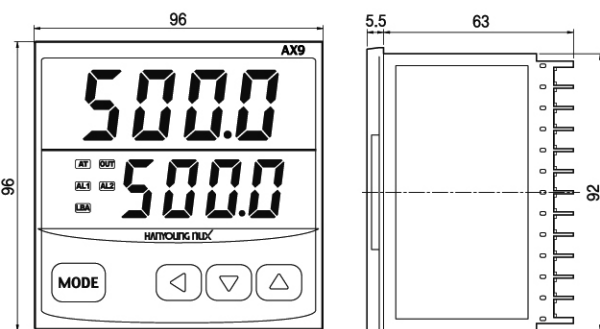

● Panel cutout

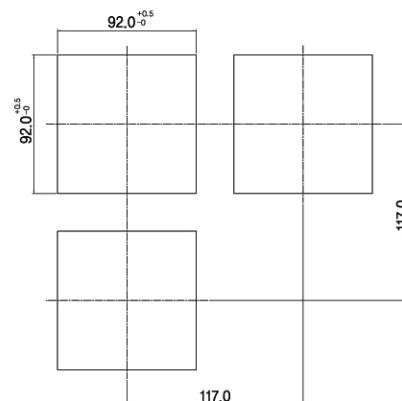

● Connection diagram

